

# UltraFlo™

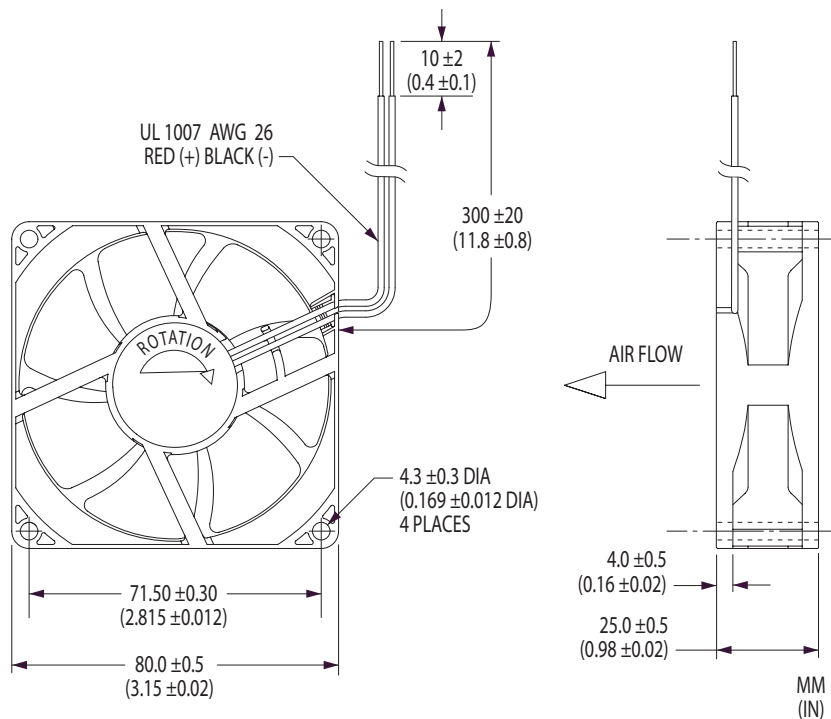

## U80T Series

- ✓ Durable, Magnetically Stabilized NBRX Sleeve Bearing Design
- ✓ Current-Limit Protection
- ✓ Optional Open-Collector Tachometer or Locked Rotor Alarm
- ✓ Plastic Housing and Impeller Rated V-0
- ✓ 12V and 24V Models



## 80 x 25mm Tube Axial Cooling Fans

Model	Air Flow (CFM)	Max. Static Pressure (inwg)	Operating Voltage		Operating Current (A)	Input Power (W)	Fan Speed (rpm)	Sound Pressure (dBA)	Operating Temp.		L10 Life† (hours)
			Nominal (V)	Range (V)					Min. (°C)	Max. (°C)	
U80T12MUA7-51	40	0.17	12	7.0-13.8	0.19	2.3	3100	30.5	-10	+70	45,000
U80T24MUA7-51	40	0.17	24	20.4-27.6	0.09	2.2	3100	30.5	-10	+70	45,000
U80T12MGA7-51	34	0.13	12	7.0-13.8	0.14	1.7	2700	27.5	-10	+70	—
U80T24MGA7-51	34	0.13	24	20.4-27.6	0.07	1.7	2700	27.5	-10	+70	—
U80T12MHA7-51	29	0.10	12	7.0-13.8	0.10	1.2	2300	22.0	-10	+70	—
U80T24MHA7-51	29	0.10	24	20.4-27.6	0.05	1.2	2300	22.0	-10	+70	—
U80T12MMA7-51	25	0.07	12	7.0-13.8	0.09	1.1	2000	17.5	-10	+70	—
U80T24MMA7-51	25	0.07	24	20.4-27.6	0.04	1.0	2000	17.5	-10	+70	—

Air flow, current, speed and sound pressure ratings are at nominal operating voltage and zero static pressure. Current and power ratings are average expected values under those conditions. † L10 bearing life expectancy at  $T_A = +40^\circ\text{C}$ .™ UltraFlo is a brand trademark of Nidec Corporation. N/A/JAC

### Recommended Standard Connectors

Connector Pitch	Manufacturer	Housing*	Contacts
1.50 mm	J.S.T.	ZHR- <i>n</i>	SHZ-002T-P0.5
2.00 mm	J.S.T.	PHR- <i>n</i>	SPH-002T-P0.5S
	Tyco/AMP	173977- <i>n</i>	Includes Contacts
2.50 mm	J.S.T.	EHR- <i>n</i>	SEH-001T-P0.6
	J.S.T. Tyco/AMP	XHP- <i>n</i> 171822- <i>n</i>	SXH-001T-P0.6 Includes Contacts
2.54 mm	Molex	2695	5159

U80T Tube Axial Fans

# UltraFlo

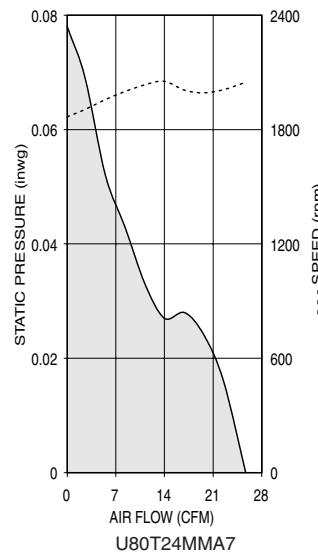
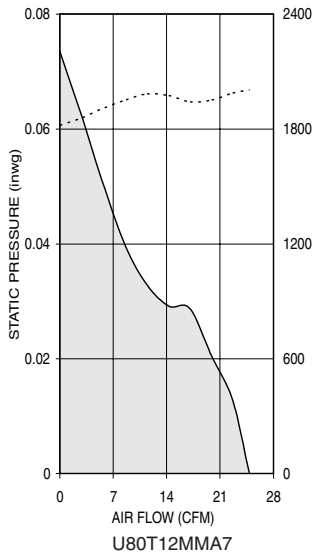
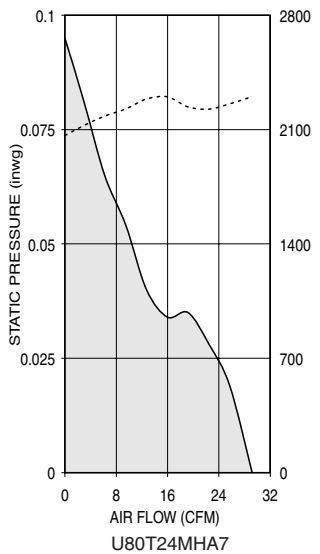
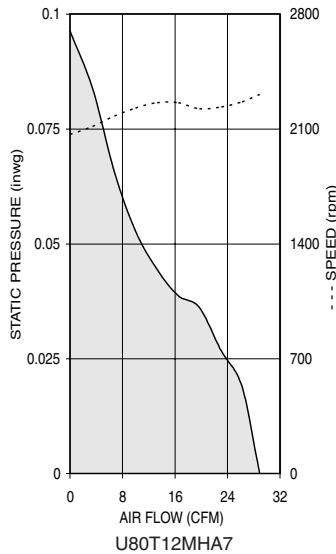
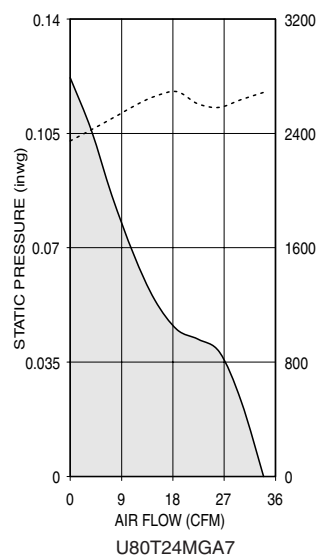
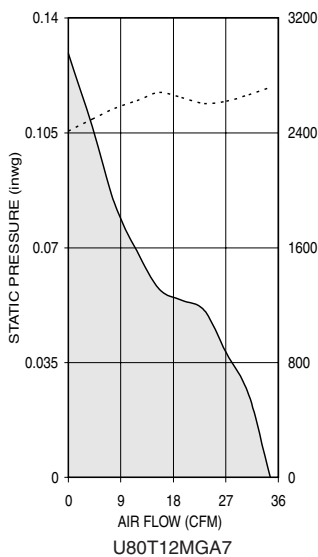
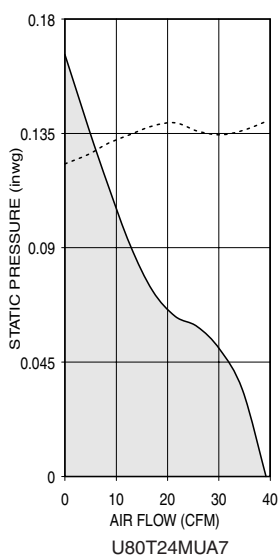
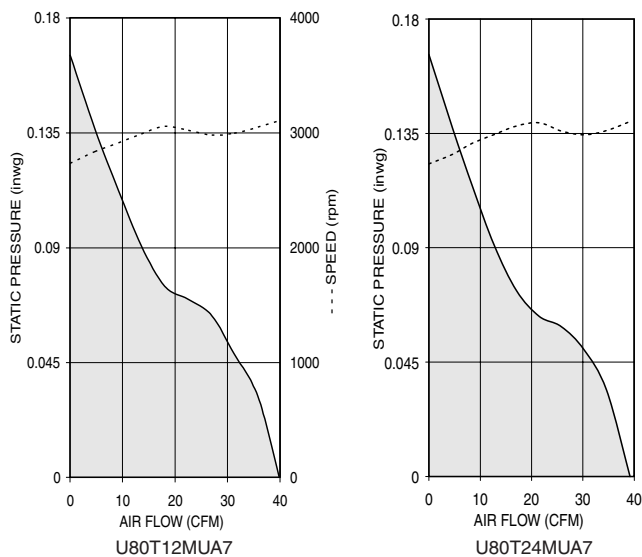

### OPEN-COLLECTOR TACHOMETER

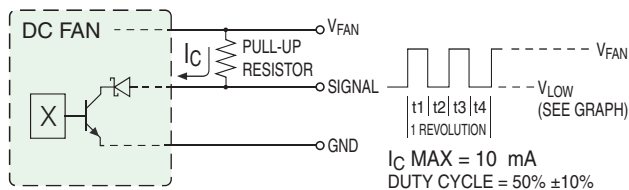

Option '-52'

### TYPICAL VALUES OF $V_{LOW}$ AS A FUNCTION OF $I_C$

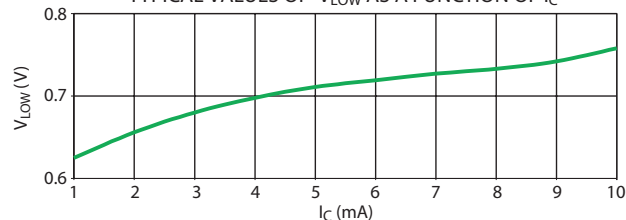

### OPEN-COLLECTOR LOCKED ROTOR ALARM

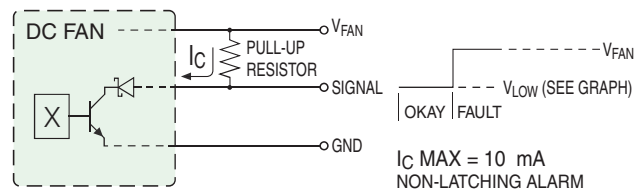

Option '-53'