

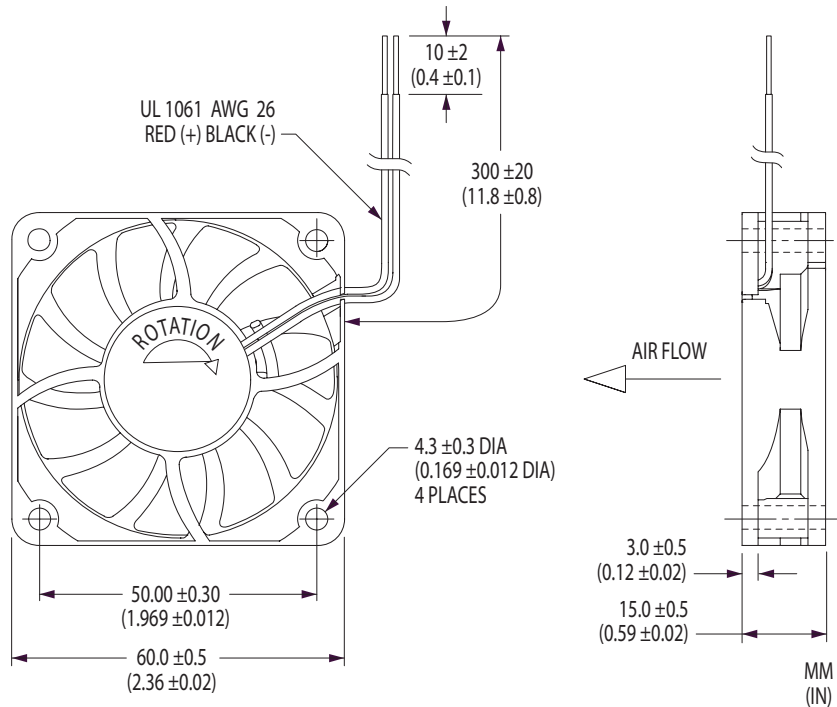

U60R Series

- ✓ Durable, Magnetically Stabilized NBRX Sleeve Bearing Design
- ✓ Current-Limit Protection
- ✓ Optional Open-Collector Tachometer or Locked Rotor Alarm
- ✓ Plastic Housing and Impeller Rated V-0
- ✓ 12V and 24V Models



60 x 15mm Tube Axial Cooling Fans

Model	Air Flow (CFM)	Max. Static Pressure (inwg)	Operating Voltage		Operating Current (A)	Input Power (W)	Fan Speed (rpm)	Sound Pressure (dBA)	Operating Temp.		L10 Life† (hours)
			Nominal (V)	Range (V)					Min. (°C)	Max. (°C)	
U60R12MGBB-51	23	0.15	12	7.0-13.8	0.16	1.9	4300	33.0	-10	+70	40,000
U60R24MGAB-51	23	0.15	24	20.4-27.6	0.09	2.2	4300	33.0	-10	+70	40,000
U60R12MHAB-51	20	0.11	12	7.0-13.8	0.12	1.4	3800	29.0	-10	+70	—
U60R24MHAB-51	20	0.11	24	20.4-27.6	0.08	1.9	3800	29.0	-10	+70	—
U60R12MMAB-51	17	0.09	12	7.0-13.8	0.09	1.1	3300	25.0	-10	+70	—
U60R24MMAB-51	17	0.09	24	20.4-27.6	0.06	1.4	3300	25.0	-10	+70	—
U60R12MLAB-51	12	0.05	12	7.0-13.8	0.05	0.6	2400	17.0	-10	+70	—
U60R24MLAB-51	12	0.05	24	20.4-27.6	0.04	1.0	2400	17.0	-10	+70	—

Air flow, current, speed and sound pressure ratings are at nominal operating voltage and zero static pressure. Current and power ratings are average expected values under those conditions. † L10 bearing life expectancy at $T_A = +40^\circ\text{C}$.™ UltraFlo is a brand trademark of Nidec Corporation. N/AJAC

Recommended Standard Connectors

Connector Pitch	Manufacturer	Housing*	Contacts
1.50 mm	J.S.T.	ZHR- <i>n</i>	SHZ-002T-P0.5
2.00 mm	J.S.T.	PHR- <i>n</i>	SPH-002T-P0.5S
	Tyco/AMP	173977- <i>n</i>	Includes Contacts
2.50 mm	J.S.T.	EHR- <i>n</i>	SEH-001T-P0.6
	J.S.T. Tyco/AMP	XHP- <i>n</i> 171822- <i>n</i>	SXH-001T-P0.6 Includes Contacts
2.54 mm	Molex	2695	5159

* The character "n" shown at the end of housing model names represents the number of contact positions available with that housing. ZHR-2, for example, identifies a housing with two contact positions.

U60R Tube Axial Fans

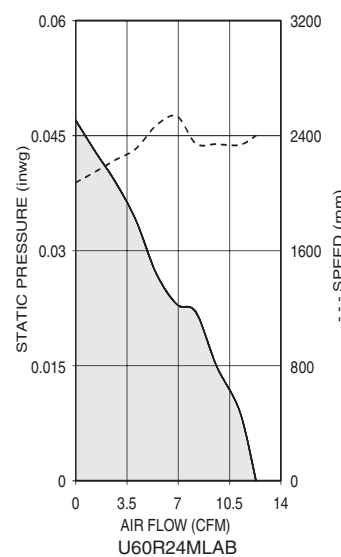
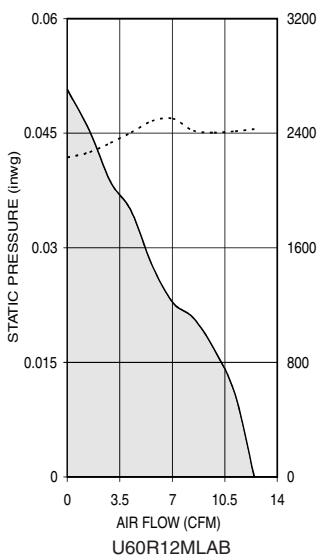
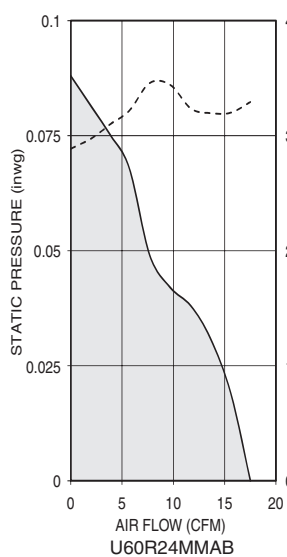
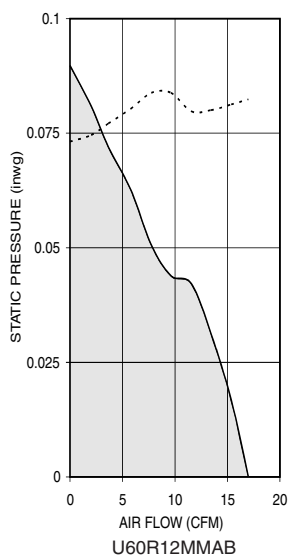
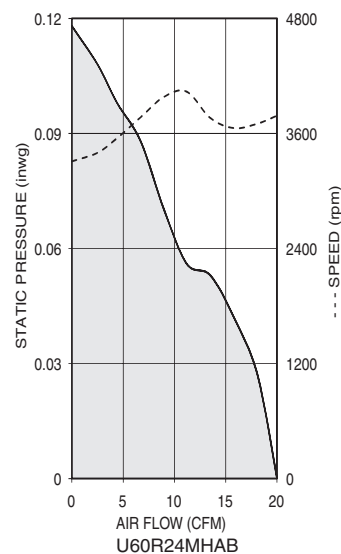
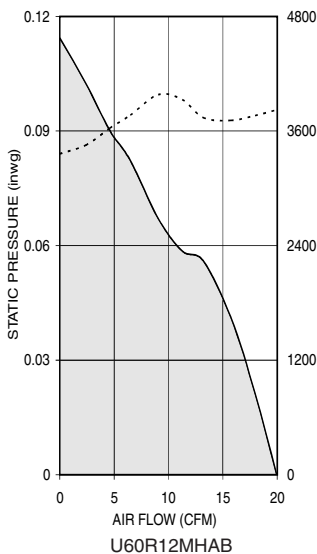
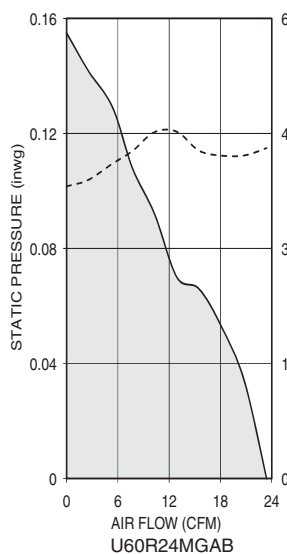
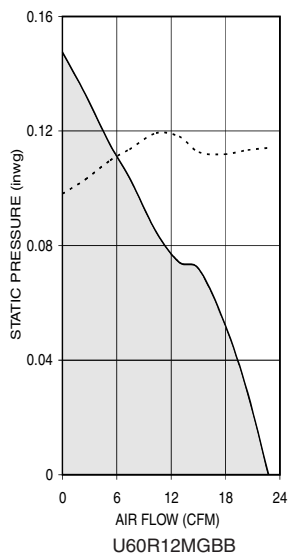

OPEN-COLLECTOR TACHOMETER

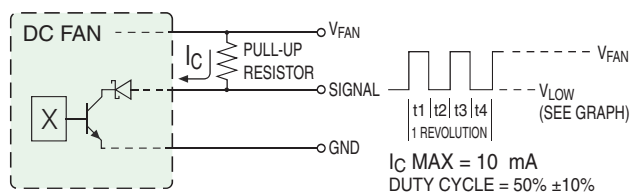

Option '-52'

TYPICAL VALUES OF V_{LOW} AS A FUNCTION OF I_C

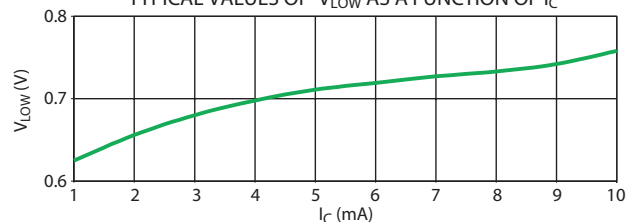

Option '-53'

OPEN-COLLECTOR LOCKED ROTOR ALARM

