

San Ace 92 GA type

Features

Large air flow and high static pressure

Maximum airflow : increased by approx. 25%
 Maximum static pressure : increased by approx. 58 % compared with our conventional product*.

Energy-saving

Power consumption is reduced by approx. 17 % with airflow performance that is identical to our conventional product*.

Low noise

Sound pressure level is reduced by approx. 8 % with airflow performance that is identical to our conventional product*.

* Our conventional product is the DC cooling fan :
 92 × 92 × 25 mm thick fan "San Ace 92" (9AH0912P4G03)



DC Fan 92mm

92 × 92 × 25mm

Specifications

Model No.	Rated Voltage [V]	Operating Voltage Range [V]	PWM duty cycle*[%]	Rated Current [A]	Rated Input [W]	Rated Speed [min ⁻¹]	Air Flow [m ³ /min] [CFM]	Static Pressure [Pa] [inchH ₂ O]	SPL [dB(A)]	Operating Temperature [°C]	Life Expectancy [h]
9GA0912P4J03 (031)	12	10.2 to 13.8	100	0.39	4.68	5,000	2.20 77.7	105 0.42	43	-10 to +70	60,000
			0	0.06	0.72	1,500	0.66 23.3	9.5 0.04	14		
9GA0912P4G03 (031)			100	0.28	3.36	4,400	1.93 68.2	81 0.33	39		
			0	0.06	0.72	1,500	0.66 23.3	9.5 0.04	14		
9GA0912P4S03 (031)			100	0.2	2.4	3,800	1.67 59.0	60.6 0.24	35		
			0	0.06	0.72	1,500	0.66 23.3	9.5 0.04	14		
9GA0924P4J03 (031)	24	20.4 to 27.6	100	0.2	4.80	5,000	2.20 77.7	105 0.42	43		
			0	0.04	0.96	1,500	0.66 23.3	9.5 0.04	14		
9GA0924P4G03 (031)			100	0.15	3.60	4,400	1.93 68.2	81 0.33	39		
			0	0.04	0.96	1,500	0.66 23.3	9.5 0.04	14		
9GA0924P4S03 (031)			100	0.12	2.88	3,800	1.67 59.0	60.6 0.24	35		
			0	0.04	0.96	1,500	0.66 23.3	9.5 0.04	14		

The numbers in () represent ribless models.

※PWM Frequency:25kHz

Common Specifications

- Material Frame: Plastics (Flammability: UL94V-0) , Impeller: Plastics (Flammability: Min.UL94V-1)
- Life Expectancy Varies for each model
 (L10: Survival rate: 90% at 60°C, rated voltage, and continuously run in a free air state)
- Motor Protection System Current blocking function and Reverse polarity protection
- Dielectric Strength 50/60 Hz, 500VAC, 1 minute (between lead conductor and frame)
- Sound Pressure Level (SPL) Expressed as the value at 1m from air inlet side
- Operating Temperature Varies for each model (Non-condensing)
- Storage Temperature -30°C to +70°C (Non-Condensing)
- Lead Wire ⊕red ⊖black Sensor: yellow Control: brown
- Mass 125g

92mm

Air Flow and Static Pressure Characteristics

• PWM Duty Cycle

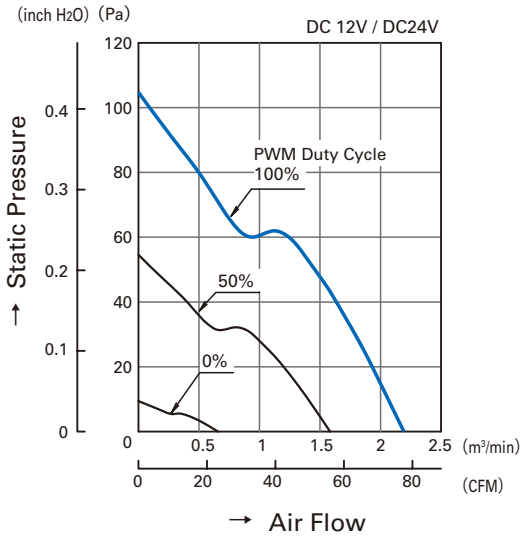

9GA0912P4J03 (031)
9GA0924P4J03 (031)

• Operating Voltage Range

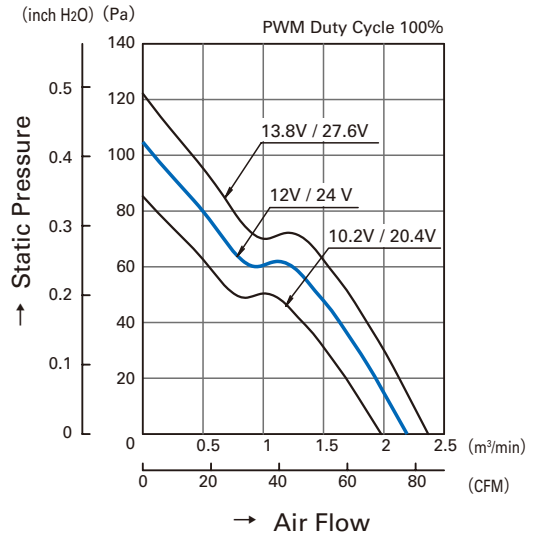

9GA0912P4J03 (031)
9GA0924P4J03 (031)

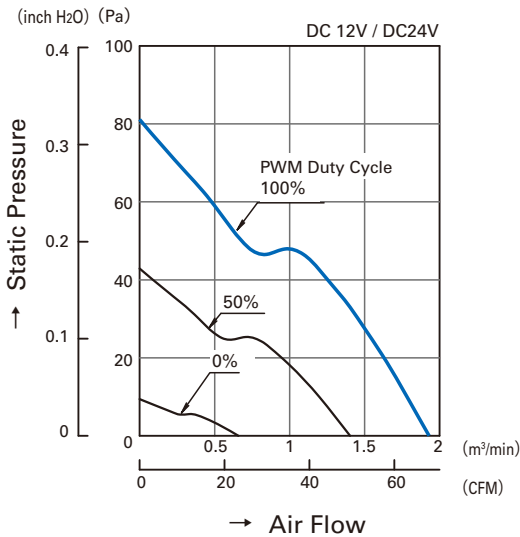

9GA0912P4G03 (031)
9GA0924P4G03 (031)

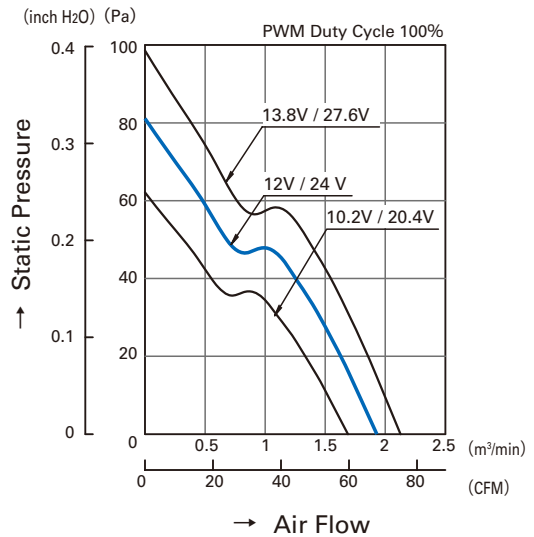

9GA0912P4G03 (031)
9GA0924P4G03 (031)

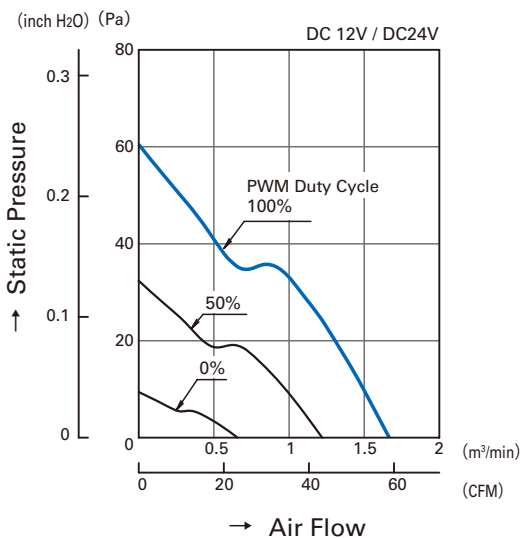

9GA0912P4S03 (031)
9GA0924P4S03 (031)

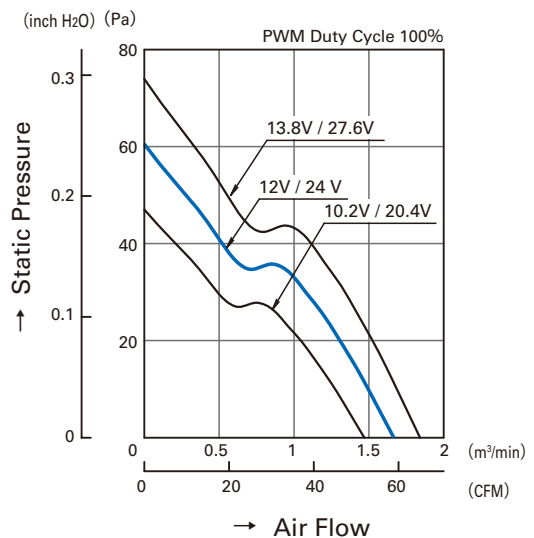

9GA0912P4S03 (031)
9GA0924P4S03 (031)

PWM Duty - Speed Characteristics Example

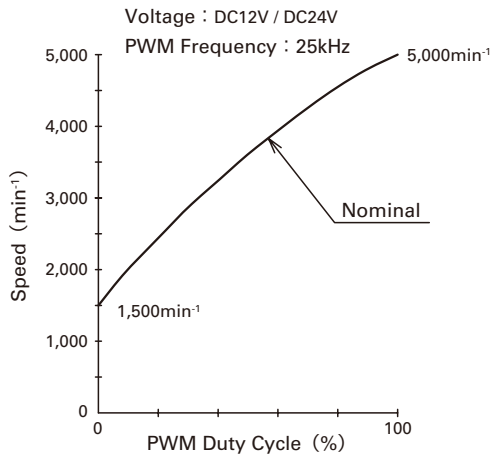

9GA0912P4J03 (031)
9GA0924P4J03 (031)

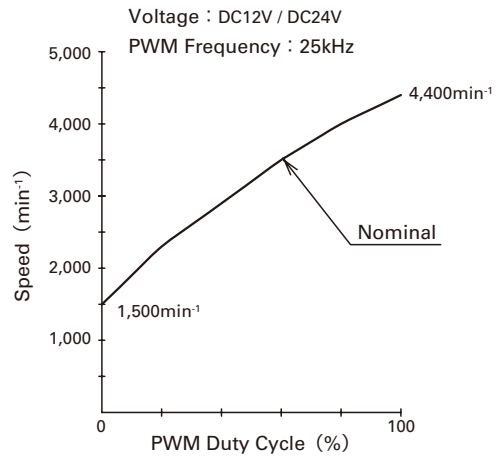

9GA0912P4G03 (031)
9GA0924P4G03 (031)

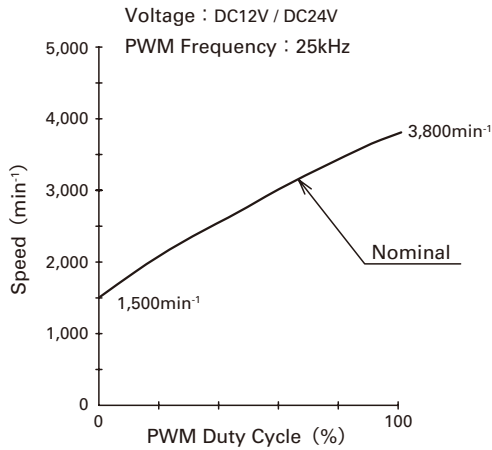

9GA0912P4S03 (031)
9GA0924P4S03 (031)

PWM Input Signal Example

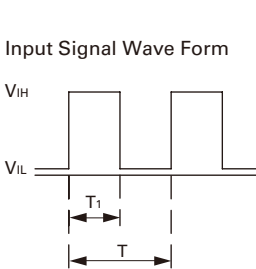

$V_{IH}=4.75V$ to $5.25V$
 $V_{IL}=0V$ to $0.4V$
 PWM Duty Cycle (%) = $\frac{T_1}{T} \times 100$
 PWM Frequency 25 (kHz) = $\frac{1}{T}$
 Source Current : 1mA Max. at control voltage 0V
 Sink Current : 1mA Max. at control voltage 5.25V
 Control Terminal Voltage : 5.25V Max. (Open Circuit)
 When the control lead wire is no connecting,
 the speed is the same speed as at 100% of PWM cycle.
 This fan speed should be controlled by PWM input signal
 of either TTL input or open collector, drain input.

Connection Schematic

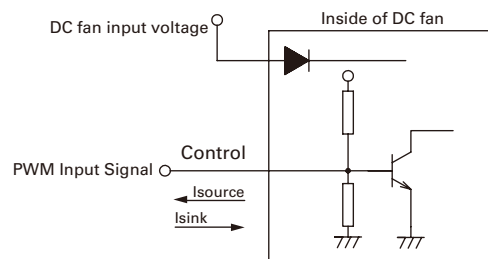

Specifications for Pulse Sensors

Output circuit : Open collector

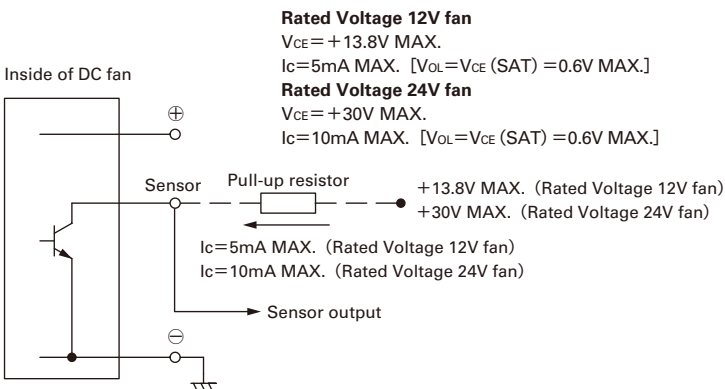

Output waveform (Need pull-up resistor)

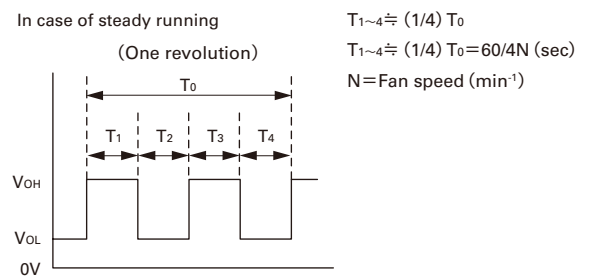

Dimensions (unit : mm) (With ribs)

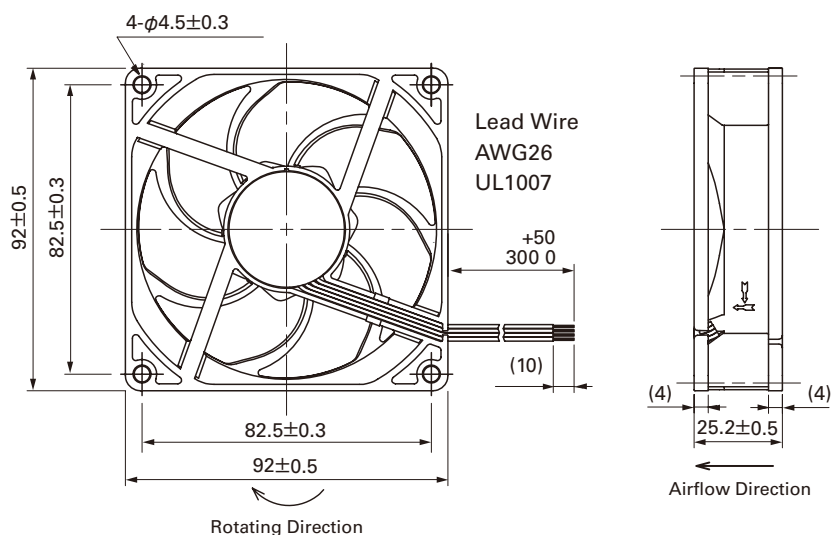

Reference dimension of mounting holes and vent opening (unit : mm)

