

UF12B Series

Size : 120 x 120 x 25
Unit : mm

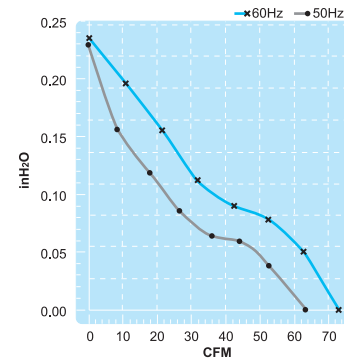
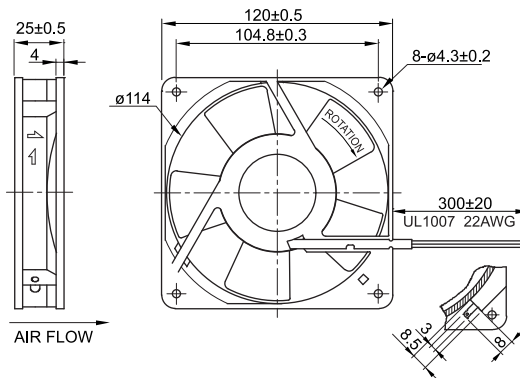

Impedance Protection

Terminal or Lead Wire Type



Spec. Model	Rated Voltage V	Frequency Hz	Input Power W	Rated Current A	Locked Current A	Speed RPM	Maximum Air Flow m ³ /min.	Maximum Air Flow CFM	Maximum Pressure mmH ₂ O	Maximum Pressure InchH ₂ O	Noise dB	Weight kg
UF12B10-H	100V	50	16	0.19	0.20	2400	1.8	64	5.3	0.21	38	0.33
		60	14	0.18	0.19	2900	2.1	75	5.4	0.21	42	
UF12B11-H	115V	50	14	0.15	0.16	2400	1.8	64	5.3	0.21	38	0.33
		60	11	0.12	0.15	2900	2.1	75	5.4	0.21	42	
UF12B20-H	200V	50	16	0.08	0.09	2400	1.8	64	5.3	0.21	38	0.33
		60	14	0.07	0.08	2900	2.1	75	5.4	0.21	42	
UF12B23-H	230V	50	16	0.08	0.09	2400	1.8	64	5.3	0.21	38	0.33
		60	14	0.07	0.08	2900	2.1	75	5.4	0.21	42	
UF12B11-L	115V	50	14	0.14	0.15	1600	1.3	46	2.4	0.09	31	0.33
		60	11	0.11	0.12	2000	1.5	53	2.9	0.11	33	
UF12B23-L	230V	50	16	0.07	0.08	1600	1.3	46	2.4	0.09	31	0.33
		60	14	0.06	0.07	2000	1.5	53	2.9	0.11	33	